

ANEXO 4



PRESENTA:
LA INSTITUCION DE EDUCACION CENTRAL Y TECNICA
 ALMENDRA JUAN PABLO Y CALLE GUADALUPE
 EDIFICIO A, SAN SALVADOR, EL SALVADOR.

PROYECTO:
 ESCUELA DE EDUCACION PARVULARIA
 CENTRO ESCOLAR
 DR. HUMBERTO ROMERO ALVAREZ

UBICACION:
 FINALIZACION INADUNA, SOGACATE.
 10147
 SOGACATE, SOPRANANTE

PROYECTO:
 CRECER Y APRENDER JUNTOS: DESARROLLO INTEGRAL
 DE LA PRIMERA INFANCIA EN EL SALVADOR

FINANCIAMIENTO:
 CONTRATO DE PRESTAMO BIRF-8967-SV

DISEÑO:
 DETALLES TIPO DE CERCO PERIMETRAL CON TUBO
 ESTRUCTURAL, CERCO PERIMETRAL PARA REJILLA,
 CERCO CON TUBO Y MALLA CICLON,
 TAPAL PREFABRICADO Y MURO DE BLOQUE

DISEÑO ARQUITECTONICO:
 DISEÑO ESTRUCTURAL

AREA TERRENO	1,379.02 M2	AREA DE CONSTRUCCION	189.38 M2
AREA CONSTRUIDA	385.12	AREA DE DISTRIBUCION	138.90 M2
NOA	OE-DET-2	COMPARTIDO	24/32
ESCALA	INDICADAS	FECHA	DICIEMBRE 2023

SEALDOS

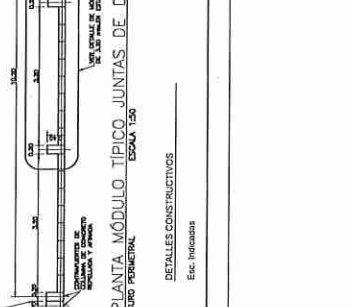
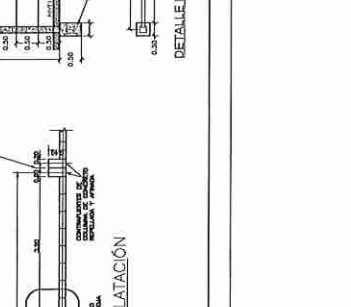
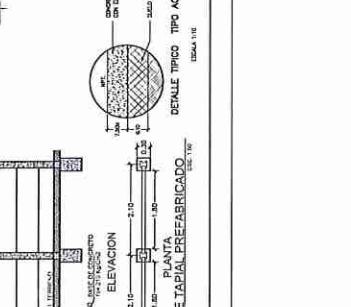
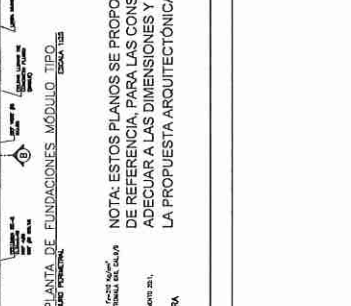
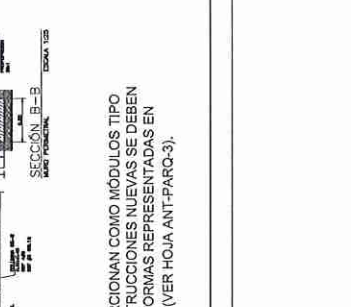
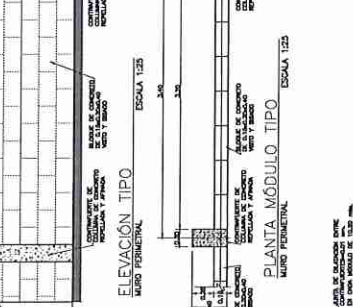
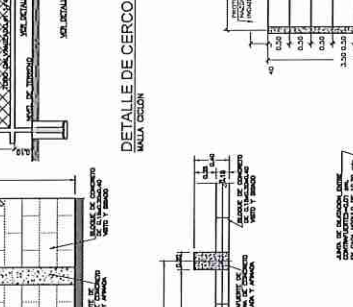
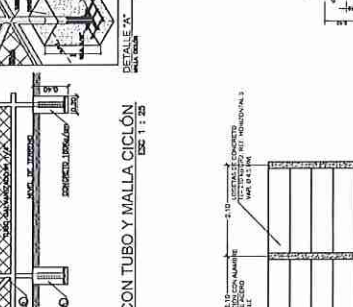
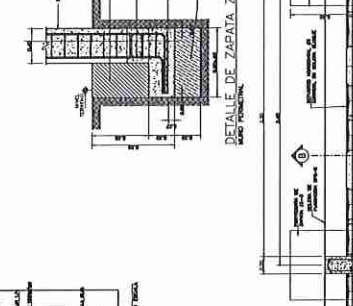
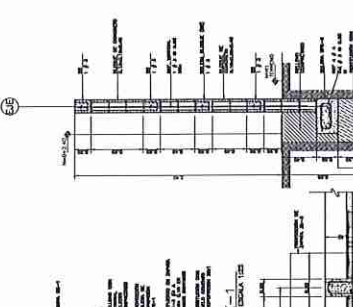
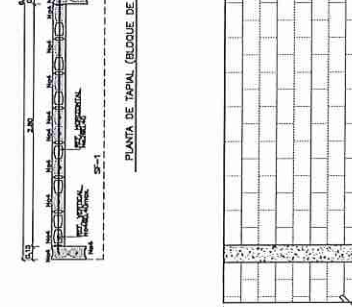
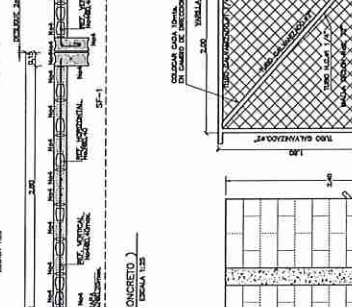
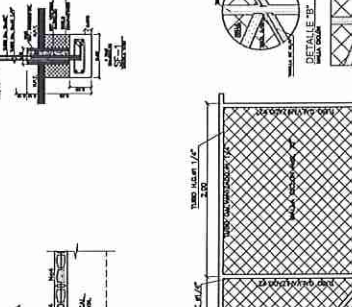
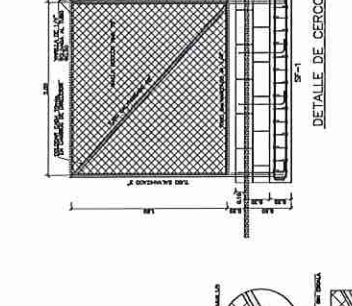
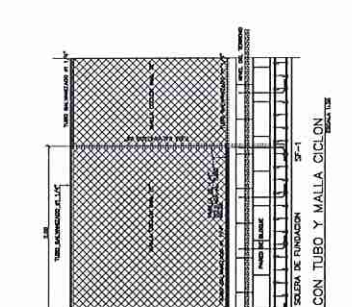
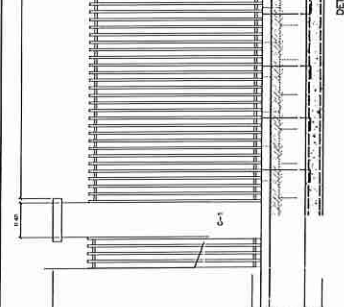
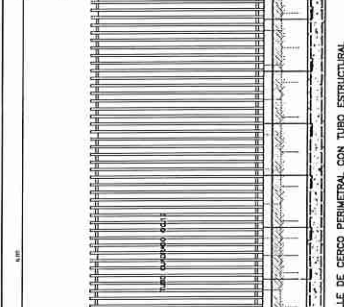
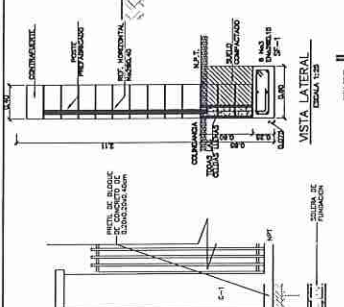
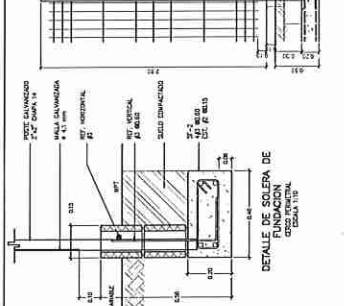
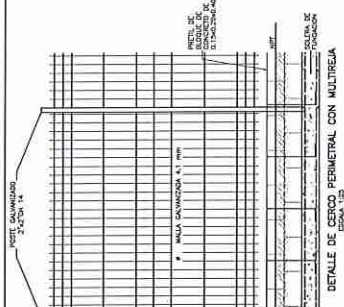

NOTA: ESTOS PLANOS SE PROPORCIONAN COMO MODULOS TIPO DE REFERENCIA. PARA LAS CONSTRUCCIONES NUEVAS SE DEBEN ADECUAR A LAS DIMENSIONES Y FORMAS REPRESENTADAS EN LA PROPUESTA ARQUITECTONICA (VER HOJA ANTIPARQ-3).

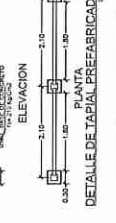
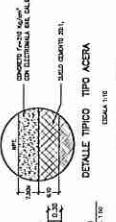

DETALES CONSTRUCTIVOS
 Esc. Indicas